

VARIO / MODUL Cooling Counters

Depth: 690 mm incl. door

Models/Lengths: VT1800 / VT2100 / VT2400 / VT2700 / VT3000 / VT3300



Congratulations

You made a good choice.

Thank you for buying this HOLLAND-Product. This cooling modul was made on the most modern production way. The full-foamed housing guarantees a low energie consumption.

This instruction shall give you some details for the assembly and the optimal use of your cooling counter.

Please contact your cooling specialist if you have further questions.

Subject to technical modifications.

Contents

1. Assembly instructions	4
2. Digital thermostat	5
Setting the temperature	
Keypad lock / unlock	
ON and OFF	
3. Defrost	6
4. Cleaning	6
5. Energy saving	7
6. Maintenance contract	7
7. Important facts	7
8. Faults	8
9. Wiring diagram	10
10. EG-Declaration of Conformity	11

1. Assembly instructions

1 The cooling unit is mounted with a automatical dewing-water-condenser.

▶ Place your counter on their right place by water level.

2 Connect the water lines.

3 If your cooling counter is mounted ready to use, please put the plug into the socket. The current has to be the same as on the Type button.



▶ For maintainance the cooling unit can be taken out of the housing. In this case, please hold the aggregat always vertically.

4 The digital controller shows the actual temperature of the housing, the ventilator works permanent. The cooling unit works emediately and cooles down, until the temperature of +4 °C is reached.





5 Before using, please clean the inside of the counter.

2. Digital thermostat LAE AT1-5



Setting the temperature

- 1 Press and hold  to display the setpoint value.
- 2 Press  or  for changing the temperature.
- 3 To escape wait 10 seconds.

Keypad lock / unlock

- 1 Press and immediately release button  ⇒ **L** will be displayed.
- 2 Press  once ⇒ **LOC** will be displayed.
- 3 Press and hold . Press  or  till **YES** or **NO** will be displayed.

ON and OFF

- 1 Press  for 3 seconds ⇒ **ON** will be displayed.
- 2 Press  for 3 seconds ⇒ **OFF** will be displayed.

3. Defrost

- ▶ The defrosting works automatically all 3 hours. The cooling unit stands still for 15 minutes. The display of the digital controller changes to „DEF“ (defrost).
- ▶ The display changes to temperature setpoint, if the wanted temperature is reached or if 10 minutes are gone.
- ▶ During the defrosting is a minimal rise of the temperature inside the counter possible. The temperature of the cooling goods will not be affected.

4. Cleaning

Please clean the cooling aggregate minimum 1 time per month.

- 1** Open the cooling unit module with a screwdriver.
 - 2** Take the plug out of the socket.
 - 3** Clean the condenser with a broom or a vacuum cleaner.
 - 4** Clean the machine case with a moist duster.
 - 5** Put the plug into the socket and close the cooling unit module.
 - 6** If necessary please clean the fronts and grips with clean water.
- ▶ For the cleaning of the inside of the housing don't take aggressive cleaners, only neutral, disinfective cleaners. Dry up the inside of the housing, to avoid an higher energy consumption as a result of frosting of the condenser.
 - ▶ The door seals should be cleaned regularly with clear water. Once in a while you have to rub the seals with talcum powder.
 - ▶ To avoid any pollution of the wastepipe of the drip tray, the waste pipe has to be cleaned after using with plenty of clear water. In case of pollution with beer mucus, please use a beer expectorant.

5. Energy saving

- ▶ Open the doors only as long as necessary.
- ▶ Check regularly the seals of the doors.
- ▶ A wasted condenser causes a higher energy consumption. Clean them as described on page 6.
- ▶ Please avoid high outside temperatures, direct sun burning or placement by a radiator, which causes a higher energy consumption.

6. Maintenance contract

- ▶ We recommend a maintenance contract with your cooling specialist.
- ▶ If you need any spare parts, please contact also your cooling specialist.

7. Important facts

- ▶ Mounting and connection of a dispensing system has to be made only by an expert, who will inform you about all facts on operating a dispensing system.
- ▶ We recommend for the installation of the water connections to contact a sanitary specialist.
- ▶ Pay attention on the right placement of the counter. The ventilation of the housing must be served!
- ▶ Noise of the cooling machine are unavoidable.
- ▶ By a longer time if none using the counter, take the plug out of the socket and open the doors for avoiding a stink.
- ▶ If you want an other arrangement of your counter, please contact your cooling specialist.
- ▶ Pay attention, that the following load-carrying capacities are not be broken:
 - Drawer: max. 100 kg
 - Bottle grate: max. 75 kg

8. Faults

- ▶ Please close the doors until your cooling specialist check the fault. Don't put new cooling goods into the counter.
- ▶ Don't try to repair the fault by yourself, if it's not possible by the list below. Otherwise the fault will become bigger and it may be dangerous if there is a defect on the electrical parts.
- ▶ At eventually fault, check first by using the following list, if you have all, in these operating instruction noted facts payed attention.
- ▶ If it's not possible to repair the fault, please contact your authorised cooling specialist.

Troubleshooting

Fault	Possible cause	Find a remedy
Display is not running	No voltage	Put the plug into the socket, controll the fuse
Mainswitch is not glowing	Mainswitch may be OFF	Check the contacts on the controller (el. know-how is recommended!)
Display shows „DEF“	Defrost mode	Wait until defrost is finished (max. 15 min). In case of demand, please ask your authorised technician to change the settings.
Temperature inside the cabinet is to low	Einstellfehler am Thermostat	Sollwert am Thermostat korrigieren
Thermostatanzeige „E1“	Fehler am Temperaturfühler	Kontakte an Thermostatrückseite überprüfen (el. Fachkenntnisse notwendig!)
		Fühler austauschen (el. Fachkenntnisse notwendig!)

Temperature inside the cabinet is to high	The controller may be wrong adjusted	Modify the set point of the controller
	The evaporator is not ventilated sufficiently	Control and cleaning of the evaporator (pull the plug outt of the socket!)
	Door gaskets are leaking	Change the door gaskets
	Evaporator fan may be damaged	Change the fan (el. know-how is recommended!)
	The cooling device is damaged	Repair by an authorised technician
	Doors or drawers are opened to long	Only open the doors as long as really nessessary
	The icing of the evaporator is to much	Correction of spacings and time of the defrost mode (el. know-how is recommended!)

9. Wiring diagram

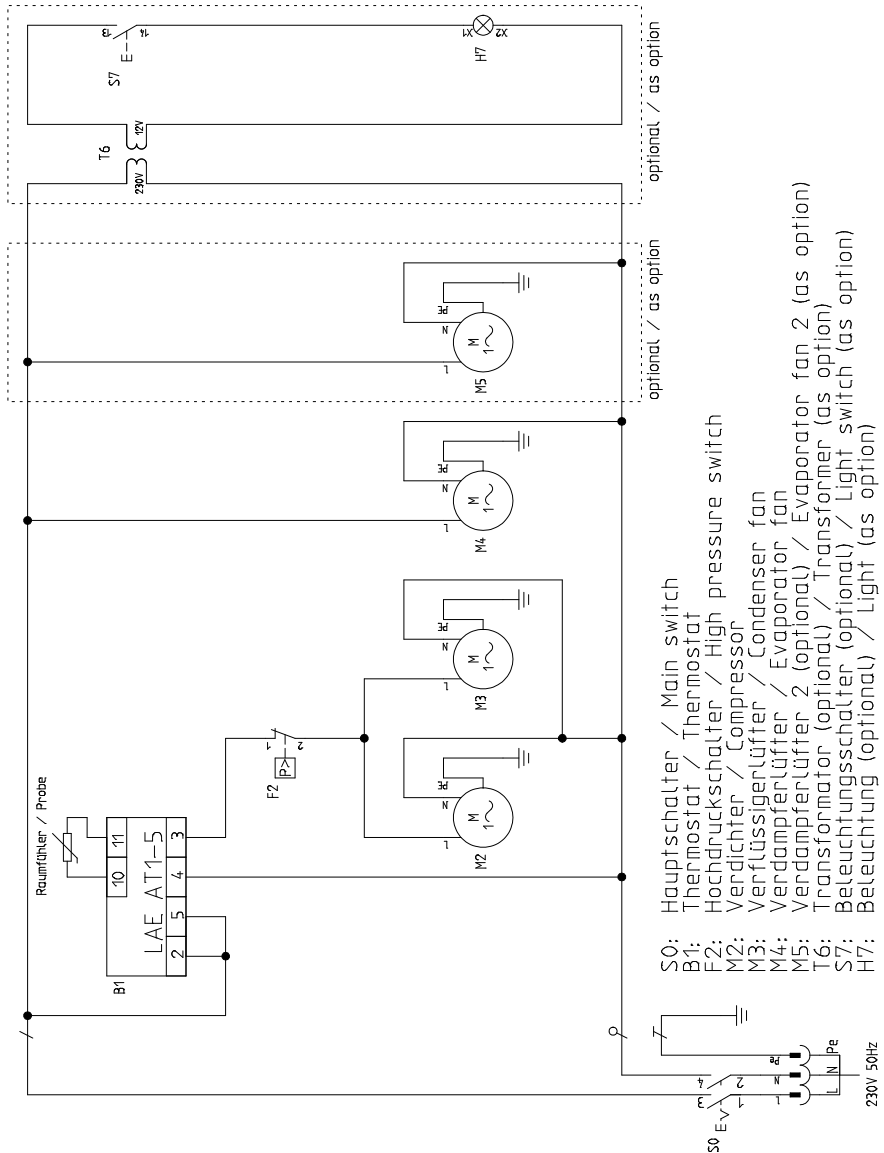

10. EG-Declaration of Conformity

(Directives 2004/108/EC + 2006/95/EC + 2006/42/EC)

Herewith we declare that this machine corresponds to the basic EEC directives for security and health demands on the basis of its conception and model, as well as of the type that we brought in circulation.

This declaration loses its validity in case of modification of the machinery to which we did not agree.

Relevant EC Directives:	EC Machinery Directive EC Low Voltage Directive EC Directive for Electromagnetic Compatibility
-------------------------	--

Applied harmonized standards:	EN 55014-1:2006+A1:2008 EN 55014-2:1997+A1:2001+A2:2008 EN 62233:2008 EN 61000-3-2:2006 EN 61000-3-3:1995+A1:2001+A2:2005 EN 60335-1:2002+A1:2004+A11:2004
Applied national standards and technical specifications:	Pressure Equipment Directive 97/23/EC 29.04.1997, VDE 0100, DIN 8975, UVV, VGB 20

Manufacturer:

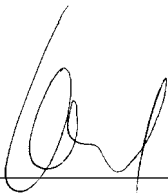

Klaus Holland
Managing director

K. & M. Holland GmbH
Industriestr. 14
94327 Bogen
Tel.: 09422 / 507-0
Fax: 09422 / 507-300

Cocktail Counters



Juice Dispensers



Mobile Bars



KEG Coolers



Big Volume Refrigerators



Your distributor